

G08

CHRISTY®

COVER

Style:	Flush
Material:	Cast Iron
Model:	11" Dia.
Weight:	14 lbs
Options:	Special Markings
Surface:	Skid Resistant & Marked*
Coefficient of Friction:	>0.6 ASTM 1028
Performance:	H20, AASHTO M309

Cover comes standard with permanent markings for manufacturer, load rating, model size and manufacturing location.

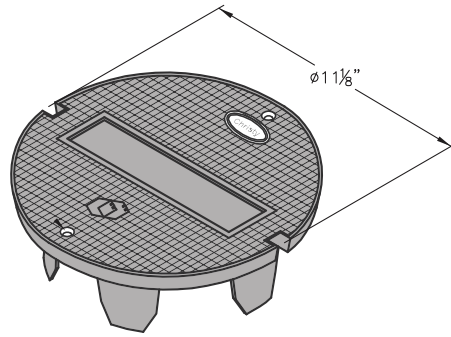

BODY

Material:	Reinforced Concrete with Steel Frame
Model:	17" Dia.
Weight:	90 lbs
Wall Type:	Straight
Mouseholes:	0
Performance:	H20, AASHTO M309

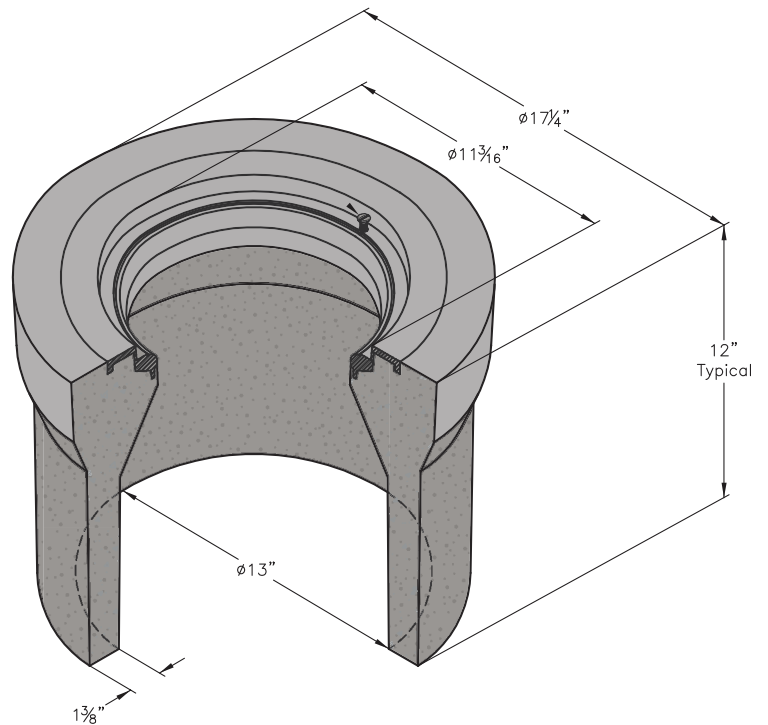

GRADE RING

Material:	Cast Iron
Grade Options:	1" Height 1-1/2" Height 2" Height

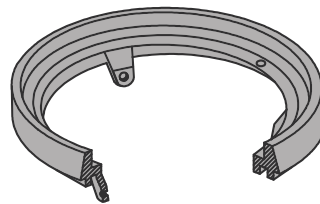

LOAD RATING / NOTES



TRAFFIC RATED
AASHTO H20

Actual load rating is determined by the box and cover combination.

WARNING: Cancer and Reproductive Harm - www.P65Warnings.ca.gov

All information contained on this sheet is current at the time of publication. Oldcastle reserves the right to discontinue or update product information without notice.

Revision 12/06/18
© 2018 Oldcastle Infrastructure