

1015 BCF

CARSON® Heavywall

12" BODY

Material:	HDPE
Model:	10" x 15"
Weight:	10 lbs
Wall Type:	Straight
Mouseholes:	0-4
Performance:	ANSI/SCTE-77 Tier 8, WUC 3.6, ASTM C857 A-8, Exceeds 20,000 lb minimum load failure

18" BODY

Material:	HDPE
Model:	10" x 15"
Weight:	13 lbs
Wall Type:	Straight
Mouseholes:	0-4
Performance:	ANSI/SCTE-77 Tier 8, WUC 3.6, ASTM C857 A-8, Exceeds 20,000 lb minimum load failure

LOAD RATING / NOTES



MEDIUM DUTY
ANSI/SCTE TIER 15

For use in non-vehicular traffic situations only.
Weights and dimensions may vary slightly.
Actual load rating is determined by the box
and cover combination.

Cover comes standard with permanent
markings for manufacturer, load rating, model
size and manufacturing location.

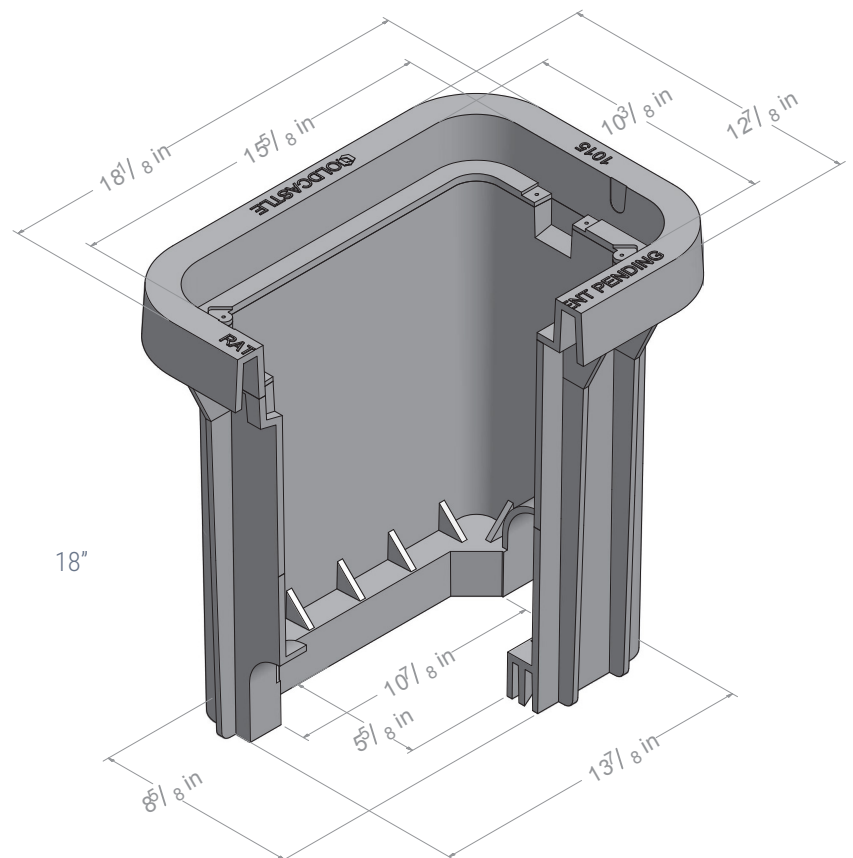
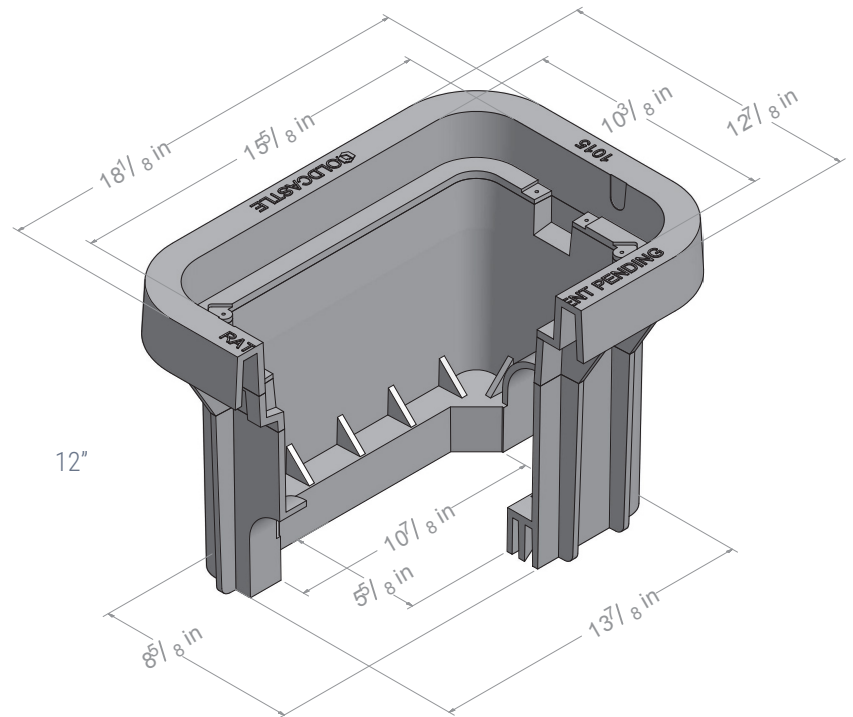

1015 BCF

CARSON® Heavywall

COVER OPTIONS

- Heavy Duty Plastic, Flush Solid
- Heavy Duty Plastic, Flush with Plastic Reader Door
- Heavy Duty Plastic, Flush with Cast Iron Reader Door
- Heavy Duty Plastic, Flush with AMR Recess
- Heavy Duty Plastic, Flush with AMR Bracket
- Polymer, Flush Solid
- Polymer, Flush with Cast Iron Reader Door
- Composite, Flush Solid
- Ductile Iron, Flush Solid
- Ductile Iron, with Max View Reader Door



HD Plastic
Flush Solid



HD Plastic
AMR Recess



Polymer
Flush Solid

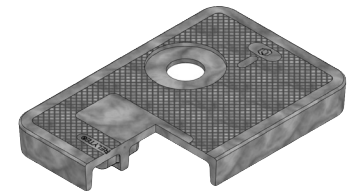

Composite
AMR Recess

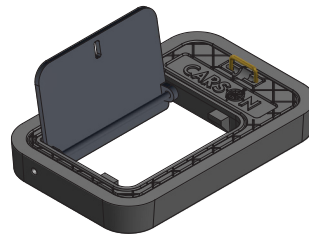

Ductile Iron
Max View Door

ADD ON OPTIONS

- Touch Read Hole
- AMR Bracket

WARNING: Cancer - www.P65Warnings.ca.gov

All information contained on this sheet is current at the time of publication.
Oldcastle reserves the right to discontinue or update product information without notice.

Revision 11/30/18
© 2018 Oldcastle Infrastructure